

**KOMATSU**<sup>®</sup>

9,000 / 10,000 / 11,000 lb Capacity

# FH40/FH45/FH50

DIESEL POWERED, PNEUMATIC TIRES, HYDROSTATIC DRIVE

Features and Specifications



**K O M A T S U**  
**F O R K L I F T U . S . A .**

# Walk-Around

## High Productivity & Low Fuel Consumption

- Built upon Komatsu's unique hydraulic and control technologies
- Superior fuel economy in high cycle operations
- Reduced CO<sub>2</sub> emissions
- Electronically-controlled Hydro-Static Transmission (HST)
- Variable displacement pump with Closed-center Load Sensing System (CLSS)
- Variable engine output control function
- Auto engine shutdown function
- Low exhaust emission engine

## Controllability & Risk Management

- Shock-free shifting
- Full auto shifting without releasing the accelerator pedal allowing the operator to focus on load handling
- "Neutral-Start" requires the shift lever to be in neutral and the brake pedal to be depressed before starting
- Speed limit settings for various work areas
- Easy operation with reduced inching pedal use required
- Simple and dependable starts on inclines





FH50-1

### Dependability & Reliability

- Highly reliable, high quality Komatsu designed & manufactured components
- Reliability is greatly enhanced by the combination of Komatsu's hydrostatic drive and wet multi-disc brake systems
- 24 volt electrical components improve engine starting in cold regions

### Easy Maintenance

- Dependable HST and wet multi-disc brake systems only require periodic checks and fluid changes for virtually the life of the truck
- Easy access for radiator checks and cleaning
- Extended service intervals reduce overall costs of ownership

### KOMTRAX®

- Utilizes GPRS cellular technology to communicate critical truck data for optimized fleet management
- Provides daily details of truck usage and fuel consumption to better manage and reduce truck operational costs
- Can provide monthly and annual operation reports to make informed fleet management decisions



FH40-1



FH45-1



# High Productivity and Low Fuel Consumption

## New FH Series Developed Using Komatsu's Unique Hydraulic and Control Technologies

The FH Series was designed to utilize highly reliable, field-proven drive and control components that have been used for many years in Komatsu construction equipment. The FH drive system is "Electronically-controlled Hydro-Static" or HST. These drive-line components have earned high marks for their quality and reliability in years of use in Komatsu construction wheel loaders and tracked machines.

The forklift's hydraulic system uses a variable displacement pump with "Closed-center Load Sensing" or CLSS that is a highly efficient hydraulic system used in Komatsu's hydraulic excavators.

All FH Series models are powered by a Komatsu designed and manufactured diesel engine that features advanced engine technologies to achieve superior fuel economy, reduced environmental impact, and outstanding controllability.

**HST – Hydro-Static Transmission**

**CLSS – Closed-center Load Sensing System**



## Reduced Fuel Consumption in High-Cycle Operations

Komatsu's HST / CLSS / and SAA4D95LE-5 Diesel Engine work in harmony to achieve significant fuel economy, especially in tough, high-cycle operations where fast-paced loading, unloading, and directional changes are prevalent.

## Reduced CO<sub>2</sub> Emissions for the Environment

Komatsu's advanced engine technologies reduce environmental impact with reduced CO<sub>2</sub> emissions.

## Komatsu's Unique HST Drive System

Komatsu's electronically controlled HST drive system replaces the torque converter and manual transmission found on conventional forklifts. With HST, the engine powers a hydraulic pump that then supplies oil flow to the hydraulic motor which drives the front wheels. With HST, you experience less power loss since both engine speed and pump delivery are controlled electronically to the optimum level for the work load. This means that you can achieve optimal performance without wasting engine power and fuel.

## CLSS With Variable Displacement Pump

Komatsu's CLSS hydraulic system has been utilized in our hydraulic excavators for many years. The load sensing capability automatically senses loading and the variable displacement pump then supplies only the amount of hydraulic fluid needed to do the job. This provides for much greater efficiency than conventional fixed displacement gear pumps, making good use of engine power to reduce overall fuel consumption.

## Engine Power Controlled By Load Weight

The load sensing capability designed into Komatsu's electronically controlled system automatically controls engine power by sensing the weight of the load to reduce needless fuel consumption.

## Auto Engine Shutdown Prevents Needless Idling

If the operator leaves the truck, applies the parking brake and sets the travel control lever to neutral, but leaves the engine running, the FH Series auto engine shutdown system will stop the engine after a set time period to prevent unnecessary fuel consumption caused by needless idling.

## Electronically Controlled HST

In the HST system, the diesel powered engine drives the pump and the oil supplied from the pump then rotates the motor that drives the forklift. The power losses over the entire engine speed range are minimal. Since the HST system does not have a clutch, which is a vital component in some torque converter forklifts, there is no possibility of heat loss or slippage which could be caused by the inching pedal during inching operations. Thus the power transmission losses are minimized which reduces fuel consumption.

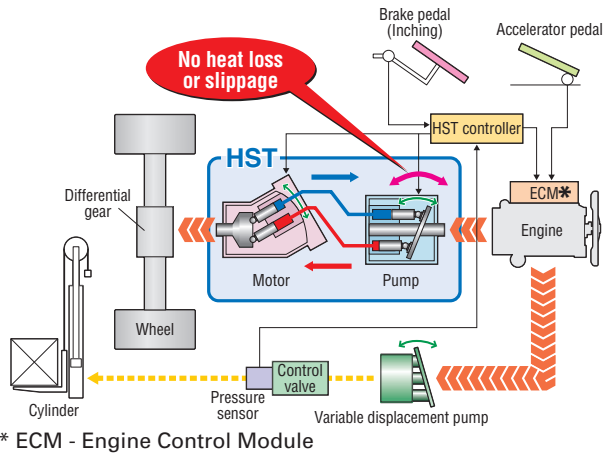

## Torque Converter-Drive Forklifts

In this type of system, the torque converter impeller receives the engine power, then transfers the power to the turbine (through the pumping action of the oil) that powers a drive system. The power transfer from the impeller to a turbine results in a power loss, thus there is less power for the drive system. In addition, this type of system might generate more heat and slippage due to slipping of the inching pedal, especially if used in a high cycle operation where the inching pedal is used frequently.

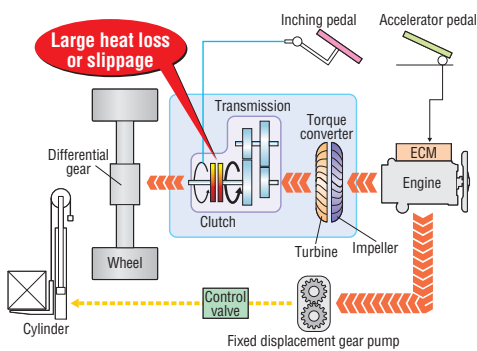

## Variable Displacement Pump with CLSS

Since the variable displacement pump supplies just the amount of oil needed to do specific work, there are no pressure losses. The system makes very efficient use of engine power, resulting in reduced fuel consumption. With CLSS the operator can lift the load with the engine running at slow speeds, further reducing fuel consumption.

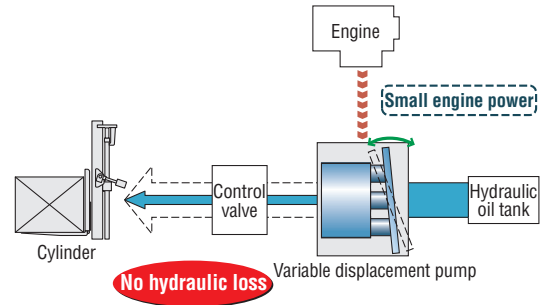

## Fixed Displacement Gear Pumps

Fixed displacement gear pumps on competitive equipment deliver a specific amount of oil per rotation, many times delivering excessive amounts of oil and leading to added loading on the engine, pressure losses, and added fuel consumption.

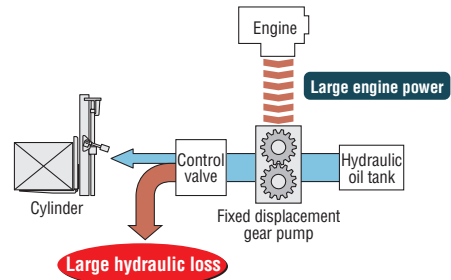

## Low Exhaust Emission Engine

Komatsu's SAA4D95LE-5, turbo-charged 4-cylinder diesel engine is Interim Tier 4 and EU Stage 3A emissions certified, without sacrificing power or productivity.

Rated Output:  
50.8 kW **68HP** @2150 rpm (Net)

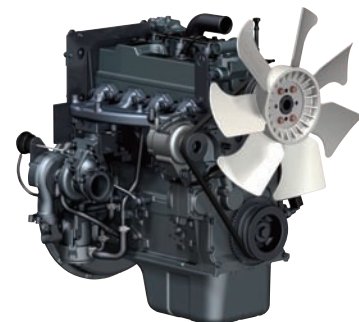

# Controllability and Operation

## Directional Changes Can Be Accomplished Smoothly Without Releasing the Accelerator Pedal Enhancing Ease of Operation

The engine is not connected to the drive system mechanically, but rather is connected hydraulically to transmit power to the drive system. This makes it possible for the FH series forklift to make directional shifts smoothly without the need to release the accelerator pedal. This greatly enhances ease of operation.



## Reduced Roll-Back on Ramps

With HST drive, the oil flow to the hydraulic motor is stopped when the accelerator pedal is released, so even if the forklift is stopped on a ramp and the operator releases the brake pedal, downhill creep is reduced. This also facilitates easier ramp-start.



## Less Inching Pedal Use Means Reduced Operator Fatigue

This HST forklift can adjust travel speed simply through the use of the accelerator pedal, reducing the need for frequent use of the inching pedal, thereby reducing operator fatigue.

## Reduced Creeping Provides More Controllable Operation

The excellent controllability of the HST system allows the operator better control when maneuvering in tight quarters, lifting, or load handling.

## Shock-free Shifting with Variable Speed Drive

Komatsu's HST system has a variable speed transmission which transmits power from the hydraulic motor to drive the tires. Since travel speeds are controlled hydraulically, the acceleration and shifting are smooth and without shock.

## Four Travel Speed Limit Settings Provide Speed Control

With the HST system, travel speeds can be set in four stages, and activated with the turtle switch. This functionality can be used to reduce speeds in tight spaces or to keep the forklift within specific in-plant speed limitations, thereby maintaining speed control.

Four travel speed settings				
km/h	5.0	8.0	15.0	23.5
mph	3.1	5.0	9.3	14.6



Turtle switch on dash

## Neutral Start-Ups

The FH engine can only start when the shift lever is set to the neutral position, the brake pedal is depressed, and the operator is in the seat. This eliminates inadvertent start-ups.





# Durability and Reliability

## Highly Reliable, High Quality Komatsu Designed & Manufactured Components

All of the FH Series main components, such as the engine, hydraulic pump, hydraulic motor, axle, and controller are designed, developed and manufactured by Komatsu ensuring high quality and reliability that comes from exacting Komatsu engineering standards.

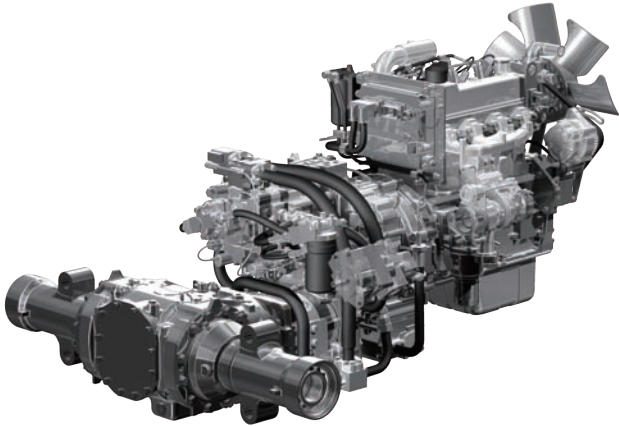

## Improved Engine Starting Performance

Komatsu's FH forklift uses 24 volt electrical components in order to improve the engine starting performance. Even in cold regions, you can depend on the FH to deliver smooth, consistent starting performance.

## Heavy-Duty Sealed Wet Multi-Disc Brakes

With many years of field-proven performance in Komatsu construction equipment, the FH's sealed wet multi-disc brake system provides excellent braking performance in all operating conditions. The sealed system provides protection from dust, dirt and debris, thus providing higher reliability, fade and water resistance. Unlike a drum brake system, there is no need to replace the brake shoes resulting in lower maintenance costs and downtime.

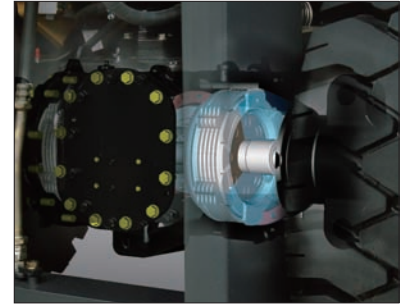

## HST Combines With Wet Multi-Disc Brakes For Greatly Enhanced Reliability

With HST reduced oil flow to the hydraulic motor helps to decelerate the forklift, so loading on the brake system is reduced which improves the reliability of both systems.



# KOMTRAX

## Komtrax Wireless Equipment Monitoring System Enhances Fleet Management

KOMTRAX, a standard feature on the FH Series, is Komatsu's remote equipment and fleet monitoring system. Leading-edge wireless technology and a secure, user-friendly, web-based application provide critical information...anytime, anywhere. KOMTRAX tells you where your machines are, what they are doing, and how they are doing it, providing total fleet management capabilities for improved fleet utilization, reduced downtime, and lower owning and operating costs. KOMTRAX can help keep your machines operating at peak performance and provides useful information on operator habits and abilities. KOMTRAX also provides the information you need to maximize output through increased efficiencies, just-in-time maintenance, and preventative maintenance.

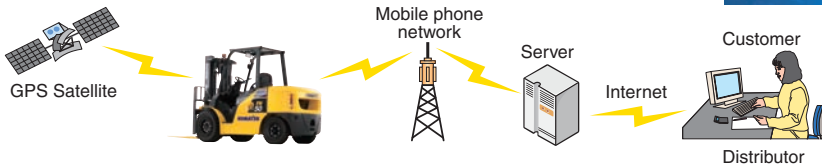

## The KOMTRAX User-friendly, Web-Based System

The KOMTRAX application is web-based and provides a wealth of information in a user-friendly format. A variety of charts and graphs, as well as useful search and filter parameters, make finding the information you need fast and easy.

## Machine Location Information

KOMTRAX uses a network of global positioning satellites to tell you where your machines are at all times. This can discourage or eliminate the possibility of theft or unapproved usage as well as providing necessary information for scheduling maintenance and operational management.

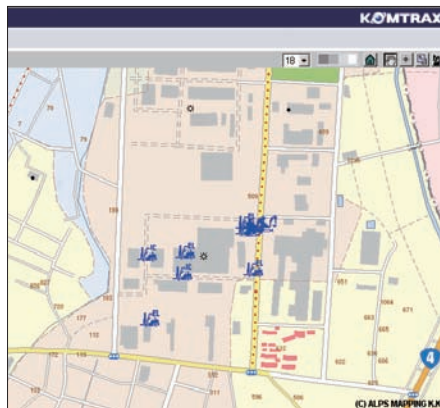

## Machine Operation Information

Getting details of machine operation on a daily basis allows owners to analyze costs and take measures to reduce those costs as needed to improve their operations bottom line.

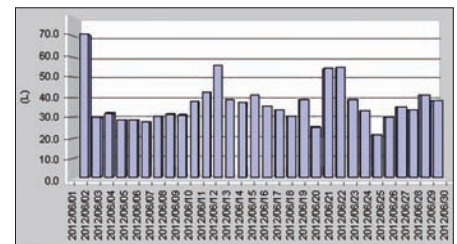
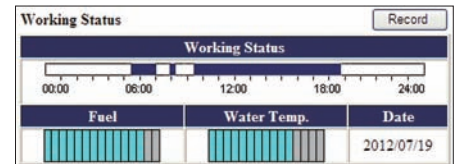

## Operation Reports

Daily, monthly, and annual reports provide summaries of all critical data to help with fleet utilization analysis, scheduling, and overall fleet management decisions.

Machine	Customer Name	Model	Type	Serial No.	Control No.	Last Date
...	...	...	...	...	...	...



# Equipment

## Standard Equipment

- Komatsu EPA Tier 4 Interim and EU stage 3A compliant diesel engine SAA4D95LE-5
  - Heavy duty high pressure common rail system
  - Air-to-air charge air cooling system
  - Sedimentor with priming pump
- Cyclone air cleaner (double element)
- Electronic engine control system
  - Overheat prevention function
  - Auto engine warm-up function
  - Auto air preheat function
- Adjustable auto engine shutdown function
- Variable displacement pump with Closed-center Load Sensing System (CLSS)
- Electronically-controlled Hydro-Static Transmission (HST)
- Wet multi-disc brakes
- Parking brake with release button
- Overhead guard with front / rear conduits
- Rear view mirror (center)
- Neutral start function
- Speed limiter "Turtle" function
- Operator presence sensing system
- Key-off lift lock
- Back-up buzzer
- Full suspension seat
- Fully hydrostatic power steering
- Tilttable steering column
- Small diameter steering wheel with spinner knob
- Steering knob synchronizer function
- Directional control lever
- Combination switch (turn signal lamp & lamp switch)
- Dash mounted display panel
  - Engine coolant temperature gauge
  - Fuel gauge
  - Hour meter (service meter)
  - Neutral pilot lamp
  - Preheating pilot lamp
  - Speed limiter pilot lamp
  - Parking brake pilot lamp
- Paper binder at engine hood
- Rubber floor mat
- Assist grip
- Halogen headlamps & rear combination lamps with bulbs
- Sealed DT type wiring harness connectors
- Flat face-to-face O-ring seals on critical hydraulic connections
- Fuel cap with key
- KOMTRAX®

### Tires:

- Front single tire, pneumatic
- Rear tire, pneumatic

### Forks:

- 42" (1070 mm) standard on FH40-1/FH45-1
- 48" (1220 mm) standard on FH50-1

## Optional Equipment

- Air cleaner with pre-cleaner, outside fitting type
- Spark-arrester
- Vertical exhaust (left side)
- Tilt cylinder boots
- Power steering cylinder protector plate
- Removable radiator screen & chassis under carriage protection (screen)
- Pressure reducing valve
- Steel cab
- Steel cab with heater & defroster
- Steel cab with air conditioner
- Canvas cab
- Front glass with wiper
- Rear view mirror (pair)
- Headlamps & rear combination lamps with LED
- Two front working lamps with LED, overhead guard mounted
- Two front working lamps with LED, fender mounted
- One rear working lamp with LED, overhead guard mounted
- Rotating lamp with LED (yellow), overhead guard mounted
- Speedometer with alarm
- Load checker with over load alarm
- Rear assist grip with horn button
- Tool kit

### Tires:

- Solid pneumatic
- Dual front drive

### Forks:

- Optional fork lengths available



# Specifications

## Specifications

	Characteristics		Manufacturer's Designation		FH40-1	FH45-1	FH50-1	
	1.2	Model						
1.3	Engine Type	Electric, Diesel, Gasoline, LPG		1	Diesel	Diesel	Diesel	
1.4	Operation Type			2	Sit-Down	Sit-Down	Sit-Down	
1.5	Rated Capacity	Q	Rated Capacity	3	9,000 (4000)	10,000 (4500)	11,000 (5000)	
1.6	Load Center	c	Rated Load Center	4	23.6 (600)	23.6 (600)	23.6 (600)	
1.8	Load Distance	x	Front Axle Center to Fork Face	5	22.8 (580)	23.2 (590)	22.6 (575)	
1.9	Wheelbase	y		6	78.7 (2000)	78.7 (2000)	78.7 (2000)	
2.1	Service Weight			7	13,867 (6290)	15,256 (6920)	16,270 (7380)	
2.2	Axle Loading	Loaded	Front	8	13,228 (9000)	21,958 (9960)	54,086 (10925)	
2.2.1			Rear	9	2,844 (1290)	3,285 (1490)	3,208 (1455)	
2.3		Unloaded	Front	10	5,710 (2590)	6,063 (2750)	6,393 (2900)	
2.3.1			Rear	11	8,157 (3700)	9,193 (4170)	9,877 (4480)	
3.1	Tire Type			12	Pneumatic	Pneumatic	Pneumatic	
3.2	Tire Size	Front		13	300-15-18PR(I)	300-15-18PR(I)	300-15-18PR(I)	
3.3		Rear		14	7.00-12-12PR(I)	7.00-12-14PR(1)	7.00-12-14PR(1)	
3.5	Number of Wheel	Front/Rear (x=driven)		15	x= driven	2x / 2	2x / 2	
3.6	Tread, Front	b10		16	48.2 (1225)	48.2 (1225)	48.2 (1225)	
3.7	Tread, Rear	b11		17	44.1 (1120)	44.1 (1120)	44.1 (1120)	
4.1	Tilting Angle	a / b	Forward/Backward	18	deg.	6 / 12	6 / 12	
4.2	Mast Height, Lowered	h1	2-stage Mast	19	in. (mm)	82.9 (2105)	86.8 (2205)	86.8 (2205)
4.3	Std. Free Lift	h2	2-stage Std. Mast, from Ground	20	in. (mm)	5.9 (150)	5.7 (145)	5.5 (140)
4.4	Std. Lift Height	h3	2-stage Std. Mast, from Ground	21	in. (mm)	118.1 (3000)	118.1 (3000)	118.1 (3000)
4.5	Mast Height, Extended	h4	2-stage Std. Mast	22	in. (mm)	162.6 (4130)	162.6 (4130)	171.1 (4345)
4.7	Height, Overhead Guard	h6		23	in. (mm)	88.2 (2240)	88.2 (2240)	88.2 (2240)
4.19	Length, with Std. Forks	L1		24	in. (mm)	166.1 (4220)	168.1 (4270)	173.4 (4405)
4.20	Length, to Fork Face	L2		25	in. (mm)	124 (3150)	126 (3200)	125.4 (3185)
4.21	Width, at Tire	b1	Single	26	in. (mm)	59.8 (1520)	59.8 (1520)	59.8 (1520)
4.22	Forks	s/e/l	Thickness x Width x Length	27	in.	2.2 x 5.9 x 42.1	2.2 x 5.9 x 42.1	2.2 x 5.9 x 48
4.23	Fork Carriage Class	ISO 2328, Type A/B/no		28	mm	55 x 150 x 1070	55 x 150 x 1070	55 x 150 x 1220
4.24	Width, Fork Carriage	b3		29	in. (mm)	46.9 (1190) / III	46.9 (1190) / III	50 (1270) / III
4.31	Ground Clearance	m1	Under Mast	30	in. (mm)	5.7 (145)	5.7 (145)	5.7 (145)
4.32		m2	at Center of Wheelbase	31	in. (mm)	8.3 (210)	8.3 (210)	8.3 (210)
4.33	Aisle Width *	Ast	with L1000 x W1200 pallet	32	in. (mm)	184.8 (4695)	187.2 (4755)	193.7 (4920)
4.34		Ast	with L1200 x W800 pallet	33	in. (mm)	190 (4825)	192.3 (4885)	193.7 (4920)
4.35	Turning Radius	Wa		34	in. (mm)	112 (2845)	114 (2895)	115.2 (2925)
5.1	Travel Speed (FWD)	Loaded		35	mph (km/h)	14.6 (23.5)	14.6 (23.5)	14.6 (23.5)
		Unloaded		36	mph (km/h)	14.6 (23.5)	14.6 (23.5)	14.6 (23.5)
5.2	Lifting Speed	Loaded		37	fpm (mm/s)	95.8 (485)	82.7 (420)	82.7 (420)
		Unloaded		38	fpm (mm/s)	99.4 (505)	86.6 (440)	86.6 (440)
5.3	Lowering Speed	Loaded		39	fpm (mm/s)	98.4 (500)	98.4 (500)	98.4 (500)
		Unloaded		40	fpm (mm/s)	98.4 (500)	98.4 (500)	98.4 (500)
5.6	Max. Drawbar Pull	Loaded 1.5 km/h, 3 min rating		41	lbs. (kN)	7,644 (34)	7,644 (34)	7,868 (35)
5.8	Max. Gradeability	Loaded 1.5 km/h, 3 min rating		42	%	33	29	28
5.10	Service Brake	Operation/Type		43		Foot/Hydraulic	Foot/Hydraulic	Foot/Hydraulic
5.11	Parking Brake	Operation/Control		44		Hand/Mechanical	Hand/Mechanical	Hand/Mechanical
5.12	Steering	Type		45		FHPS	FHPS	FHPS
6.4	Battery	Voltage/Capacity at 5-hour rating		46	V/ah	24/52	24/52	24/52
7.1	Make Model			47		KOMATSU	KOMATSU	KOMATSU
7.2		Rated Output, net	SAEJ1349		48		SAA4D95LE-5**	SAA4D95LE-5**
7.3	Rated Speed			49	HP (kW)	68.1 (50.8)	68.1 (50.8)	68.1 (50.8)
7.3.1	Max. Torque, net	SAEJ1349		50	rpm (min-1)	2150	2150	2150
7.4	No. of Cylinder/Displacement			51	lb-ft (Nm) @ rpm	212 (287) @ 1400	212 (287) @ 1400	212 (287) @ 1400
7.6	Fuel Tank Capacity			52	cu. in. (litr)	4 / 199 (3.26)	4 / 199 (3.26)	4 / 199 (3.26)
8.2	Relief Pressure for Attachment			53	U.S. gallons (liters)	27.7 (105)	27.7 (105)	27.7 (105)
8.2.1	Hydraulic tank Capacity			54	psi (bar)	2988 (206)	2988 (206)	2988 (206)
8.7	Transmission			55	U.S. gallons (liters)	21.9 (83)	21.9 (83)	21.9 (83)
				56		Hydrostatic	Hydrostatic	Hydrostatic

\* : VDI 2198 includes 200 mm 7.87" clearance \*\* : EPA Interim Tier 4 and EU Stage 3A Emission Certified

## Load Capacity Curve

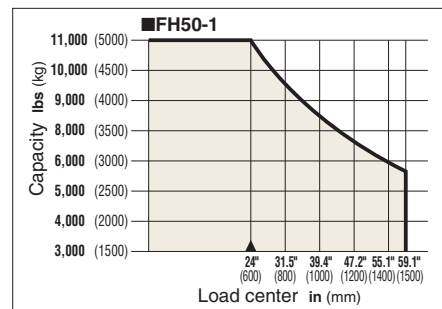
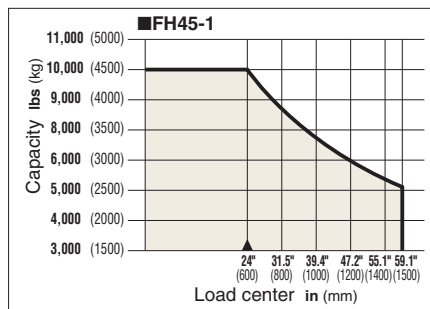
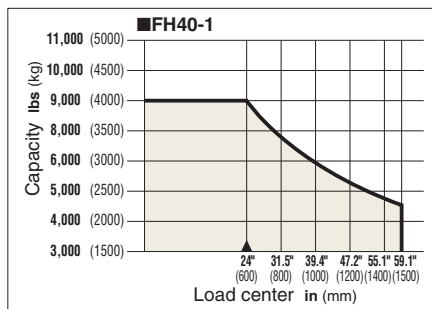

## Dimensions

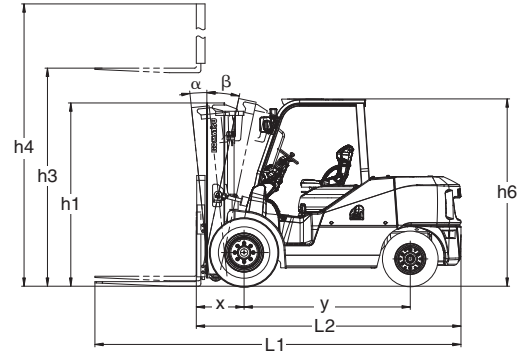
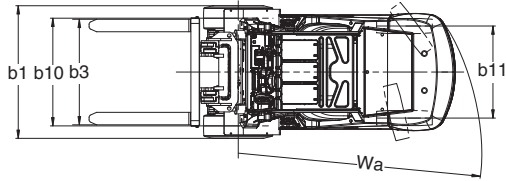

## Mast Specifications

### ■ 2-stage free view mast

	Maximum fork height		Overall height						Tilting angle F / B	
			Lowered height		Extended height		Free lift			
			mm	in	mm	in	with STD load backrest mm	with STD load backrest in	with STD load backrest mm	with STD load backrest in
FH40-1 9,000 lb	3000	119	2300	90.5	4240	167	175	7	6/12	6/12
	3300	130	2450	96.5	4520	178	175	7	6/12	6/12
	3500	138	2555	100.5	4725	186	175	7	6/12	6/12
	4000	158	2805	110.5	5230	206	175	7	6/12	6/12
	4475	177	3060	120.5	5715	225	175	7	6/6	6/12
FH45-1 10,000 lb	3000	119	2300	90.5	4240	167	175	7	6/12	6/12
	3300	130	2450	96.5	4520	178	175	7	6/12	6/12
	3500	138	2555	100.5	4725	186	175	7	6/12	6/12
	4000	158	2805	110.5	5230	206	175	7	6/12	6/12
	4475	177	3060	120.5	5715	225	175	7	6/6	6/12
FH50-1 11,000 lb	3000	119	2350	92.5	4240	167	175	7	6/12	6/12
	3300	130	2500	98.5	4520	178	175	7	6/12	6/12
	3500	138	2605	102.5	4725	186	175	7	6/12	6/12
	4025	159	2885	113.5	5260	207	175	7	6/12	6/12
	4475	177	3110	122.5	5715	225	175	7	6/6	6/6

### ■ 3-stage full free view mast

	Maximum fork height		Overall height						Tilting angle F / B	
			Lowered height		Extended height		Free lift			
			mm	in	mm	in	with STD load backrest mm	with STD load backrest in	with STD load backrest mm	with STD load backrest in
FH40-1 9,000 lb	3700	146	2020	79.5	4930	194.1	1150	45.3	6/6	6/6
	4000	158	2120	83.5	5230	205.9	1250	49.3	6/6	6/6
	4300	170	2225	87.5	5535	217.9	1355	53.3	6/6	6/6
	4525	179	2300	90.5	5765	227.0	1430	56.3	6/6	6/6
	4675	185	2350	92.5	5920	233.1	1480	58.3	6/6	6/6
	5000	197	2450	96.5	6225	245.1	1580	62.3	6/6	6/6
	5975	236	2780	109.5	7215	284.1	1915	75.3	6/6	6/6
FH45-1 10,000 lb	3700	146	2020	79.5	4930	194.1	1150	45.3	6/6	6/6
	4000	158	2120	83.5	5230	205.9	1250	49.3	6/6	6/6
	4300	170	2225	87.5	5535	217.9	1355	53.3	6/6	6/6
	4525	179	2300	90.5	5765	227.0	1430	56.3	6/6	6/6
	4675	185	2350	92.5	5920	233.1	1480	58.3	6/6	6/6
	5000	197	2450	96.5	6225	245.1	1580	62.3	6/6	6/6
	5975	236	2780	109.5	7215	284.1	1915	75.3	6/6	6/6
FH50-1 11,000 lb	3750	148	2095	82.5	4980	196.1	1125	44.3	6/6	6/6
	3975	157	2170	85.5	5205	204.9	1200	47.3	6/6	6/6
	4300	170	2275	89.5	5535	217.9	1305	51.3	6/6	6/6
	4525	179	2350	92.5	5765	227.0	1380	54.3	6/6	6/6
	4675	185	2400	94.5	5920	233.1	1430	56.3	6/6	6/6
	5000	197	2500	98.5	6225	245.1	1530	60.3	6/6	6/6
	5975	236	2830	111.5	7215	284.1	1860	73.3	6/6	6/6



The FH Series was designed to utilize highly reliable, field-proven drive and control components that have been used for many years in Komatsu construction equipment. The FH drive system is "Electronically-controlled Hydro-Static" or HST. These drive-line components have earned high marks for their quality and reliability in years of use in Komatsu construction wheel loaders and tracked machines.

# FH40/FH45/FH50

DIESEL POWERED, PNEUMATIC TIRES, HYDRO-STATIC DRIVE

## STRONG CUSTOMER SATISFACTION

Komatsu Forklift has a strong corporate commitment to produce, deliver and support quality products, and we have always made customer satisfaction our top priority. We will work to the best of our ability to help you maximize your operation's productivity while minimizing costs.

## QUALITY PRODUCTS & SERVICES

Komatsu Forklift offers an expanding product line of over 120 electric and internal combustion engine forklift models with capacities from 2,000 to 35,000 pounds. We back them with a complete warranty program, superior service, and genuine OEM parts.

## CONTACT YOUR DEALER TODAY

Your nearby Komatsu Forklift dealer is ready to assist you. Ask about financing and leasing programs that can be tailored to your business plan. Forklifts for your specific applications and workplace are waiting for you now.

## Komatsu Dealer Network

Komatsu Forklift has over 195 dealer locations throughout the United States, Canada, Mexico, the Caribbean, and Central and South America. Komatsu dealers are staffed with dedicated teams of professionals who are trained to meet your forklift needs.

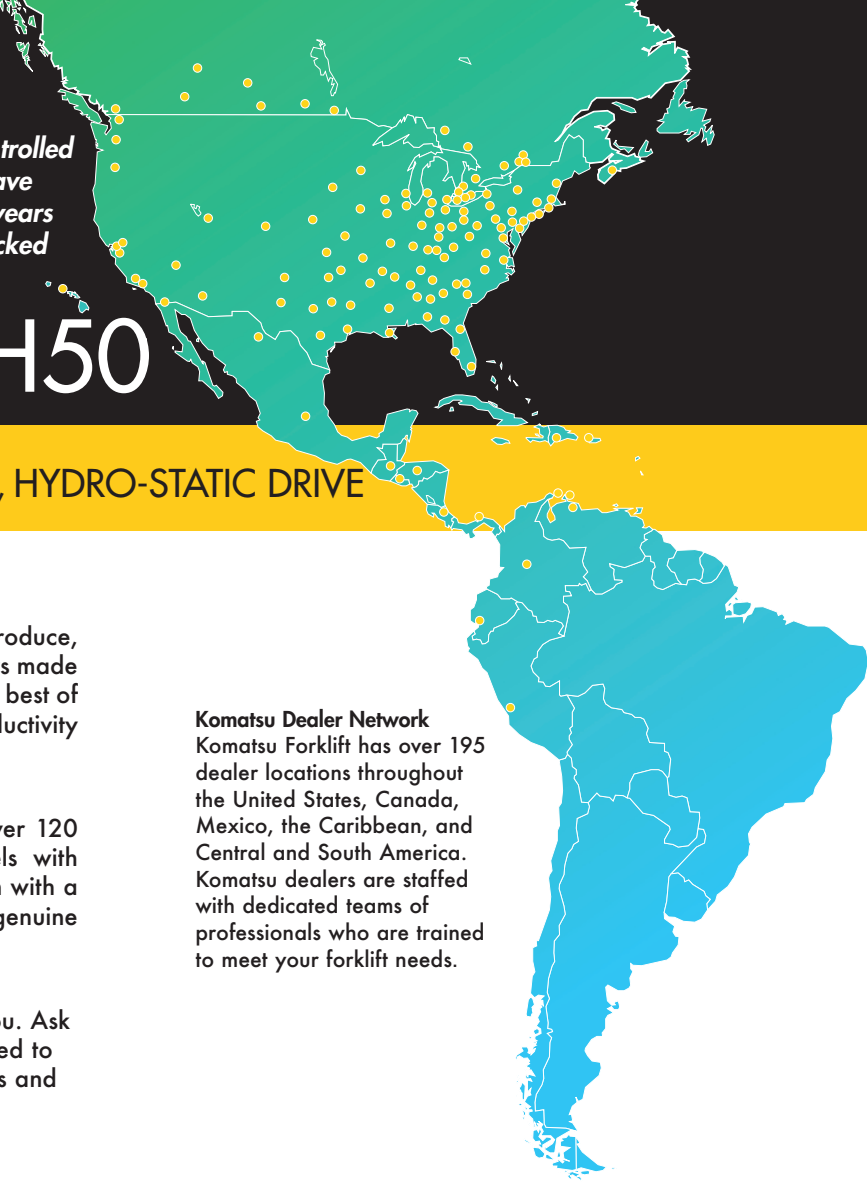

## THE KOMATSU HERITAGE

As part of the Komatsu family, we have a proud heritage of excellence in equipment design and manufacturing. Since 1921 Komatsu has been a global leader in the construction and mining equipment industry. And since 1945, we have built upon that heritage by producing innovative, high-quality, durable forklifts to meet and exceed the needs of our customers.



KOM98-00

©2013 Komatsu America Corp.

Printed in USA

AD01(1M)KM

01/13 (EV-1)

# KOMATSU®

[www.KomatsuAmerica.com](http://www.KomatsuAmerica.com)

[www.KomatsuForkliftUSA.com](http://www.KomatsuForkliftUSA.com)



Komatsu America Corp. is an authorized licensee of Komatsu Ltd. Materials and specifications are subject to change without notice. Photos may include optional equipment. **KOMATSU®** and **KOMTRAX®** are registered trademarks of Komatsu Ltd., Japan